

Installation and Service Guide

Reverse Osmosis System with Quick-Connect Fittings



USRO4-60-QC / USRO4-60-QC-38 / USRO4-100-QC-38



USRO5-60-QC / USRO5-60-QC-38 / USRO5-100-QC-38

**Please read this manual carefully
before attempting installation**

SYSTEM AND FAUCET DIAGRAM

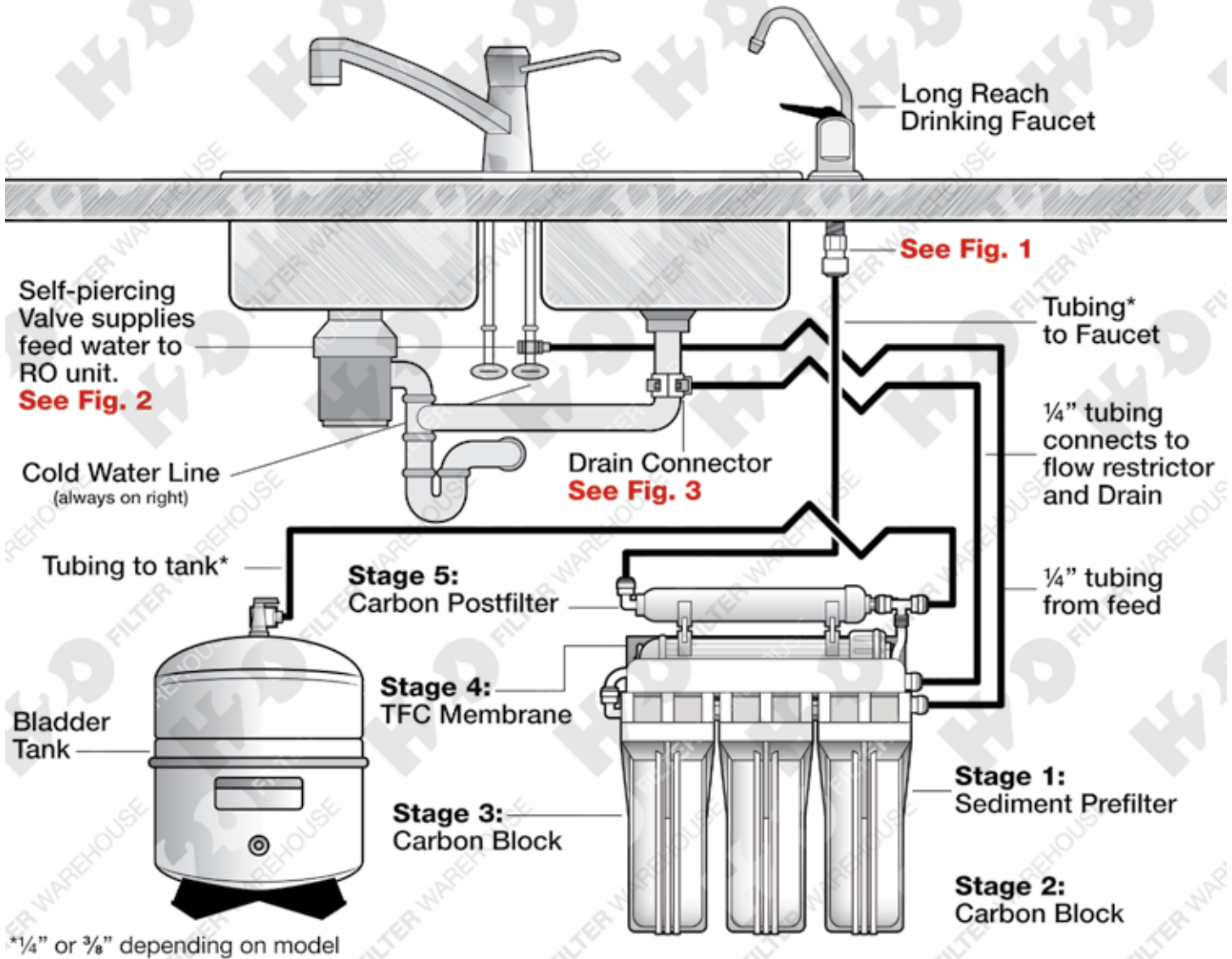

QUICK-CONNECT FITTINGS — HOW TO MAKE A CONNECTION

Connecting standard quick-connect fittings

Push up to pipe stop.

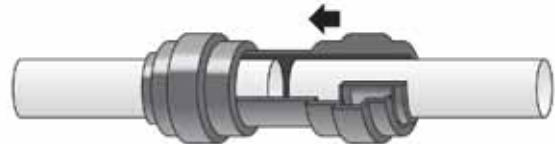

Push the pipe into the fitting, to the pipe stop. The collet (gripper) has stainless steel teeth which hold the pipe firmly in position while the 'O' Ring provides a permanent leak proof seal.

Pull on the pipe to check it is secure. It is good practice to test the system prior to leaving site and/or before use.



Disconnecting standard Quick-connect fittings

Ensure system is depressurized before removing fittings. Push in the collet against the face of the fitting. With the collet held in this position the pipe can be removed. The fitting can then be re-used.

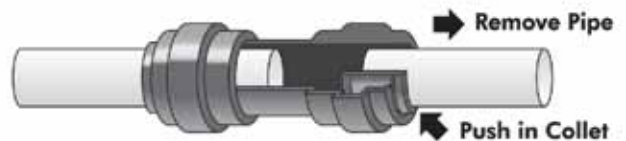

Your Reverse Osmosis (RO) System has been tested to ensure it will operate correctly. The following periodic maintenance is recommended so your system will provide years of trouble-free service:

- Prefilters (sediment) Once per year
- Prefilter (carbon block(s)) Once per year
- RO Membrane Usually Every 2 years
- Postfilter (carbon) Once per year

System Components

The following components make up your reverse osmosis system:

Prefilter #1 (sediment) Melt Blown Polypropylene filter removes larger particles such as dirt, rust & sediment.

Prefilter #2 (& 3 if applicable) 10 Micron Carbon Block removes chlorine and chemical contaminants in the feed water and protects the RO membrane.

Reverse Osmosis Membrane Thin Film Composite Membranes reduces dissolved minerals, metals, and salts. In this process, harmful compounds are separated by the membrane from the water, and the contaminants are flushed to the drain.

A coconut shell activated carbon **postfilter** is provided for a final "polish" and to remove tastes, odors and to provide great tasting water.

The **RO module** is the main component and holds the prefilters and membrane, and postfilter. A bracket is provided so they can be mounted under the sink or in a basement.

Bladder tank holds RO purified water, ready to use.

Automatic shut-off valve closes when the storage tank is full and shuts off the water supply to conserve water. The valve activates when the tank pressure is 2/3 of the feed pressure.

The **RO Faucet** is used to dispense purified water when you want it.

Feed water saddle valve connects to the cold water line to supply water to the RO system.

Wastewater saddle valve connects to the drain to remove reject water from the RO system.

Tubing connects all RO components.

Quick-Connect fittings are used for necessary tubing connections. These fittings connect by pushing the tube into the fitting past a slight resistance until the tube bottoms out in the fitting. Simply make a clean cut in your tubing

and gently push in the tubing until it will not go any further. To ensure that your tubing has made a snug fit, pull back gently on the tubing; it should catch. Always check for leaks to ensure a watertight connection. (see Figure 1)

Tools

The following tools may be necessary, depending on each particular installation:

$\frac{3}{8}$ " variable speed electric drill (2,500 RPM is best for stainless steel); $\frac{1}{8}$ ", $\frac{1}{4}$ " & $\frac{1}{2}$ " metal cutting bits
 $\frac{1}{8}$ ", $\frac{1}{4}$ " & $\frac{1}{2}$ " Concrete drill bits (for porcelain sinks)
Phillips head screw driver
6" adjustable wrench
Teflon tape & Plastic tubing cutter
Hammer & Center punch

System Location

Your RO system may be installed under a sink or in a basement. Do not install unit where it would be exposed to freezing temperatures. Connecting to an icemaker or other remote location can also be considered if a connection can be made without using more than 12" of tubing, otherwise a delivery pump may be needed. Farther runs can be attempted and a pump can be added later only if needed.

Guidelines for component placement are as follows:

Faucet should be placed on, or near the sink where drinking/cooking water is normally required. A 2" flat surface is required to mount faucet if an existing hole is not available. The thickness of the mounting surface should not exceed $\frac{1}{4}$ " or a faucet extension (not supplied) will be needed.

Bladder Tank maybe placed where it is convenient, within ten feet of the faucet. Under the sink or in a nearby cabinet or in basement rafters are excellent choices. Full tanks can weigh more than thirty pounds; so make sure any shelving used is secure. Bladder tank can be placed on its side or upright.

RO Unit may be mounted on either side of the sink, in the back of a cabinet, or in the basement. Mounting the unit on the left or the right side of the cabinet under the sink provides for easier access to the unit for future maintenance.

A Self Piercing Valve is used to supply a feed water connection to the RO unit. Locate this assembly as close to the RO unit as possible. Connect to a portable, cold water supply line only. A self-piercing valve can be used on copper or chrome plated copper tubing, CPVC, & flexible gray riser tubes at least $\frac{3}{8}$ " in size. It should not be used on ribbed, corrugated, reinforced plastic or steel braided tubing. Ask your local dealer which alternatives can be used in place of the self-piercing valve if one cannot be installed under your sink.

A Drain Saddle is used to make a waste water connection with your drain under the sink. This is designed to fit around a standard 1-1/2" OD drainpipe. The drain saddle valve should always be installed before (above) the p-trap and on the vertical or horizontal tailpiece. Do not install the drain saddle near a garbage disposal to avoid clogging the drain line with debris.

Unit preparation

Open shipping carton, remove components and check that all parts are present.

Installation Steps

All plumbing must be completed in accordance with state and local plumbing codes. Some municipalities may require installation by a licensed plumber. Check your local plumbing codes for more information.

1. Faucet Installation

If the sink has a sprayer, it may be disconnected for faucet installation. A pipe cap or plug will be necessary to seal the sprayer connection or sprayer can be left connected under the sink.

To make the faucet-mounting hole (if sprayer hole or other existing hole is not used), check below to make sure the drill will not interfere with anything below. A 2" flat surface is required, not exceeding 1-1/4" thickness.

The faucet should be positioned so it empties into the sink and the spout swivels freely for convenience. If the sink has a hole that can accommodate the RO faucet, no drilling is required. Proceed with mounting the faucet.

Installation procedures for Porcelain, Enamel, Ceramic on Metal, or Cast Iron:

Precautions must be taken to penetrate the porcelain through to the metal base and prevent chipping or scratching.

Procedures:

1. Mark the center with center punch for the 1/4" pilot hole.
2. Carefully drill pilot hole with masonry bit through porcelain and stop when metal shows. (Use light pressure and slow speed)
3. Switch the bit to a standard metal cutting bit to continue to cut through the metal below the porcelain surface.
4. Continue to enlarge the pilot hole with larger masonry & metal cutting bits until the hole is 1/2".

Installation procedures for Stainless Steel Sinks:

Procedures:

1. Mark the center with center punch for the 1/4" pilot hole.
2. Drill the pilot hole
3. Continue to enlarge hole with larger size drill bit until it is 1/2".
4. Clean up sharp edges

Note: Air Gap Faucets are required by some municipalities. These faucets require a 1 1/4" hole in the sink rather than the 1/2" hole required by the standard faucet included with the RO system. To make a 1 1/4" hole to accommodate an air gap faucet requires special tools such as a chassis punch (stainless steel) or a Relton cutter (porcelain) if a large enough hole is not already available. Ask your local dealer for more information.

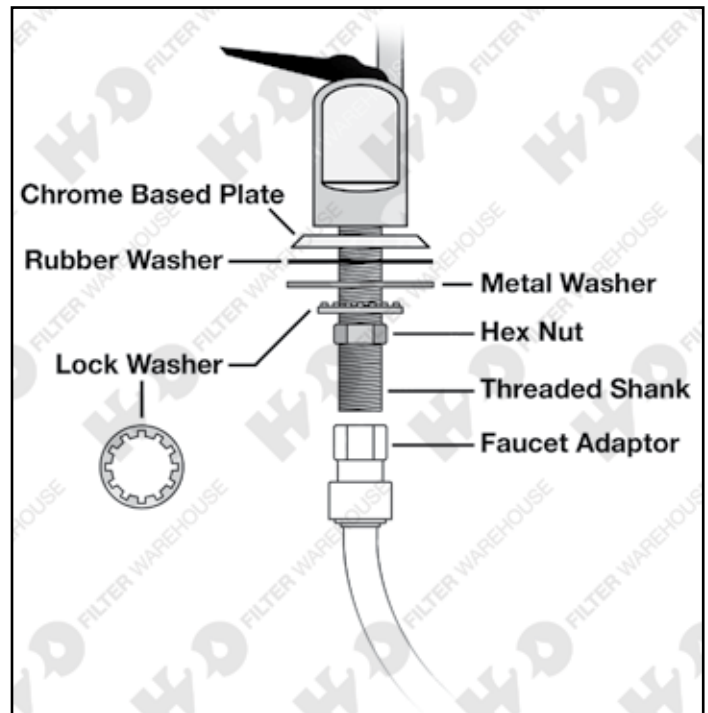

Fig. 1

2. Mounting the Faucet

Disassemble hardware from the threaded shank. Chrome base plates and rubber washers slide up the shank to the faucet body.

Feed threaded shank through the sink hole and orient the faucet. From below sink, slide lock washer and hex nut over threaded shank and tighten with a wrench.

Note: It is best to have someone hold the faucet from above the sink to keep it from moving out of place. If this is not possible then tighten the hex nut until it is just slightly less than completely tight. Then turn the faucet base from above the sink, tightening it while orienting the faucet in the desired location.

3. Self Piercing Valve and Tubing Installation

The self-piercing valve, which is supplied, is designed for use with 3/8" to 1/2" OD copper or chrome plated copper tubing, CPVC, & flexible gray riser tubes at least 3/8" in size. It should not be used on ribbed, corrugated, reinforced plastic or steel braided tubing. Ask your local dealer what alternatives can be used in place of the self-piercing valve if one cannot be used under your sink.

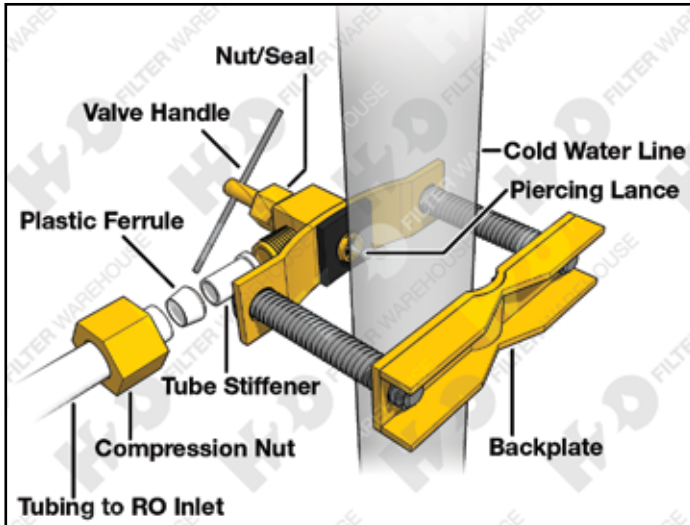

Fig. 2

Installation procedures using copper tubing/pipe or tubing, CPVC, and gray flexible riser tubes:

(See Figure 2)

1. Turn off cold-water valve from under the sink or main water line valve for whole house.
2. Before installing saddle valve, make sure piercing lance does not protrude beyond rubber gasket.
3. Assemble saddle valve on tube/pipe (As shown in Figure 3)
4. Turn handle clockwise until it stops to pierce tube/pipe, (Valve is closed in this position)
5. Turn on water supply to pressure cold water line.
6. Snug nut/seal with wrench around valve stem.
7. Connect tubing to feed water valve using brass compression nut, stiffener insert and plastic sleeve.
8. To open valve, turn handle counterclockwise.

Saddle valve installations with other metal pipe:

1. Turn off cold water supply.
2. Drill 3/16" hole at desired location.
3. Make sure piercing lance does not protrude beyond rubber gasket.
4. Assemble saddle valve on pipe, aligning with hole.
5. Turn saddle valve handle clockwise to close valve.
6. Tighten nut/seal around valve stem with wrench.
7. Connect tubing to feed water valve using brass compression nut, stiffener insert and plastic sleeve.
8. Turn on cold water supply.
9. To open valve, turn handle counterclockwise.

4. Drain Saddle Valve Installation

(See Figure 3)

A Drain Saddle is used to make a wastewater connection with the drain under the sink, which is designed to fit around a standard 1-1/2" OD drainpipe. The drain saddle valve should always be installed before (above) the p-trap and on a vertical or horizontal drain. Do not install the drain saddle near a garbage disposal to avoid clogging the drain line with debris.

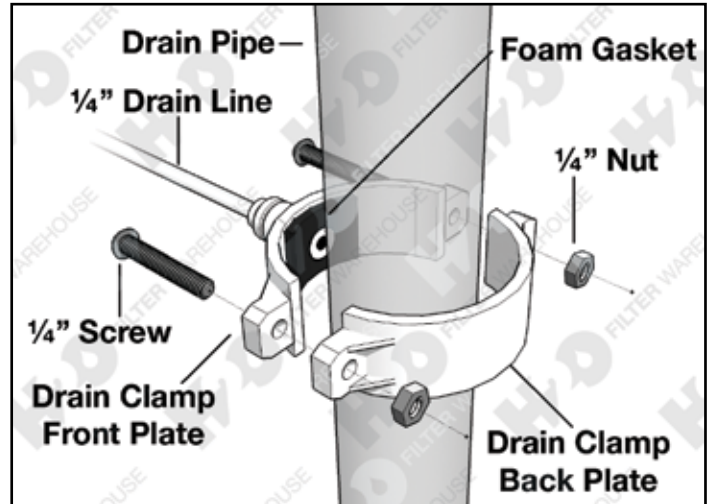

Fig. 3

Procedures:

1. Position the drain saddle valve at selected location and mark for the opening.
2. Drill 1/4" hole at mark through one side of pipe.
3. Remove backing from gasket and place adhesive side to the fitting half of drain clamp around hole.
4. Position both halves of drain saddle on drain pipe so the opening aligns with drilled hole. Use a small drill bit to verify that drain clamp is properly aligned.
5. Secure drain saddle clamp on valve with bolts and nuts provided. (Do not over tighten and make sure there is equal space between saddle halves on each side)

5. Initial tubing connections

For convenience on under sink installations it may be advisable to complete under sink tubing connections at this time.

6. RO Component Installation

Install RO membrane O-ring end first, carbon prefilter(s) and sediment pre filter in vertical mounted housings. Be sure RO Membrane is pushed into Membrane housing as far as it will go. It is recommended that filters and membranes be handled with clean or gloved hands.

7. RO Unit Installation

The RO unit is normally mounted to the right or left sink cabinet sidewall, depending on where supply tank is to be located. Generally the unit is installed at the front of the cabinet and the tank at the rear.

To mount the unit, elevate it at least 2" off the floor, level it and mark the location of mounting holes needed. Drill hole for mounting screws and install screws allowing the mounting bracket slots to slip over them.

Note: If the cabinet sidewalls are not solid, unit may sit on the floor with screws used just to keep it against the cabinet in a vertical position.

8. Pre-fill, Sanitizing and Supply Tank Placement

Pre-filling the storage tank is always recommended so there is sufficient pressure to check for leaks and sufficient water to flush the carbon post filter. To do this connect the feed line that will serve the RO unit and connect it directly to the bladder tank. Allow the water to fill the bladder until it stops. Then close to tank valve and let this stand for 15 minutes. Remove the tube and connect to inlet fitting of the RO unit.

The supply tank should be placed under the counter or within 10 feet of the RO unit.

Note: Tanks are pre-pressurized with air at 7 psi.

9. Final Tubing Connections

With all components in place, complete final tubing connections with these guidelines:

1. Tubing should follow contour of the cabinets.
2. Cut tubing to correct length using square cuts and a proper cutting tool
3. Make sure there are no crimps in the tubing.
4. Keep tubing from the RO unit to the tank and faucet as short as possible for good flow.
5. The Drain line is a short 1/4" tube connected to the membrane housing. On this tube is a 3" cylindrical drain flow restrictor. This is where the drain line connects to the RO unit. Do not remove the drain flow restrictor as this will cause a failure in the system.

Icemaker hookup (optional and requires a T fitting and additional shut-off valve not supplied with RO unit)

The RO unit can be connected to any standard refrigerator icemaker or ice maker/water dispenser.
(Do not connect to a commercial type bar icemaker)

To complete this operation, connect a T with a shut off valve into the faucet tubing and route tubing to the refrigerator. (Hooking up to existing copper tubing is not recommended due to possible corrosion) Turn off icemaker inside freezer prior to turning off the existing tap water supply line to the refrigerator. Turn on the icemaker after

the RO system has been drained several times and the tank has a full supply of water.

Icemaker lines are often run in the rafters of unfinished basements or finished basements with drop ceilings and then up to the fridge. If the basement has a hard ceiling, this won't be an option and the line would have to be run through cabinets. In cases where a basement or cabinets connecting sink and fridge are not available, icemaker connections cannot be made.

Note: Before any service is performed on the RO system, turn off icemaker valve and icemaker unit. Turn back on only after RO system has been sanitized and flushed out.

System Start-up

Prior to start-up:

1. Check all fitting connections.
2. Open self-piercing valve, allow system to pressurize and check for leaks.
3. Open valve on bladder tank and open faucet until water flows.
4. Close faucet, wait five minutes and check for leaks.
5. Allow system to produce a full tank of RO water. (2-3 hours)

Flushing System and Checking Operation

1. Flip the faucet lever up and this will keep faucet on. Do this and allow tank to completely drain of all water.

! Do not use this water !

2. Close faucet and re-inspect system for leaks.
3. Allow system to produce water for 4 hours, at this point the bladder tank will be full.
4. Open faucet again and allow tank to empty for a second time.

! Do not use this water !

5. Close faucet and allow unit to produce another tank of water.
6. At this point supply line to ice maker connection (optional) may be opened and RO water is ready to be consumed.

Replacing Filters & Sanitizing The System

Each year the filters in the system should be replaced. Usually the membrane can be replaced every other year, but the prefilters and post-filter should be changed annually and in some cases more often.

Filter Replacement

1. Turn off valve on RO bladder tank.
2. Turn off feed water pressure.
3. Open RO faucet to relief pressure.

4. Using the supplied housing wrench remove the filter housing.
5. Discard old filters.
6. Clean filter housings with a cleaning brush
7. Follow sanitizing steps in "Sanitizing the System" section
8. Install new filters in system.
9. Remove and replace GAC Post filter. Remove fittings from old post filter, re-apply Teflon tape and install fittings in new post filter.
10. Turn on feed pressure.
11. Open tank valve.
12. Allow water in tank to flush out post filter and run to drain until empty. Run 2 more complete batches to drain before using water.

Membrane Replacement

1. Remove the supply tube from the end of the membrane housing that has only 1 tube.
2. Unthread the cap from the membrane housing.
3. Remove membrane using a pair of pliers.
4. Clean membrane housing with a brush.

Note: When installing a new membrane be sure to push the membrane into the housing as far as it will go. Each time the filters are replaced it is recommended that the system be sanitized.

Sanitizing the System

After all filters are removed from the system, housings have been cleaned, tank is empty, and faucet is open...

1. Add 1 gallon of water to a clean bucket.
2. Add 1 teaspoon of unscented household bleach.
3. Add 1 cup of this solution to each filter housing.
4. Tighten filter housings with solution on RO assembly.
5. Connect membrane housing and feed tube.
6. Open tank valve and feed pressure valve.
7. Allow water to fill the RO housing assembly until water comes out of faucet.
8. Close the faucet
9. Allow water to run for 5 minutes.
10. Shut-off feed pressure.
11. Allow solution to stand for 30 minutes.
12. Open faucet and allow system to drain.
13. Remove water from housings before installing new filters and membrane.
14. Install new filters, tighten housings, and reconnect all tubing connections.
15. Open feed pressure valve and check for leaks.
16. Allow the system to make a full tank of water.
17. Run 2 cycles to drain to rinse out sanitizing solution before using water.

Troubleshooting

RO Systems are highly sensitive to pressure and temperature. RO Membranes always perform better under

higher pressures. They produce more water, faster, and of better quality with high pressure. The vast majority of problems with RO Systems are a result of low pressure. The effects of low pressure include water constantly running to the drain, slow water production and low water volume available in storage tank. In these cases where low pressure exists, a booster pump will be required.



IT IS HIGHLY RECOMMENDED THAT YOUR SYSTEM BE SANITIZED EACH YEAR.

On the following page is a table showing RO Membrane performance over a range of temperatures and pressures. Membranes are tested at 65 psi of pressure and temperature of 77 degrees. For each incremental change in either variable, membrane performance changes accordingly. Higher pressures increase production and vice versa.

To troubleshoot a poor performing RO System an accurate measure of the pressure and temperature of water will be required. This will require a pressure gauge to determine exactly what the water pressure is that is feeding the membrane. Descriptions of water pressure such as good, high or strong, unfortunately, are no help in diagnosing an RO System.

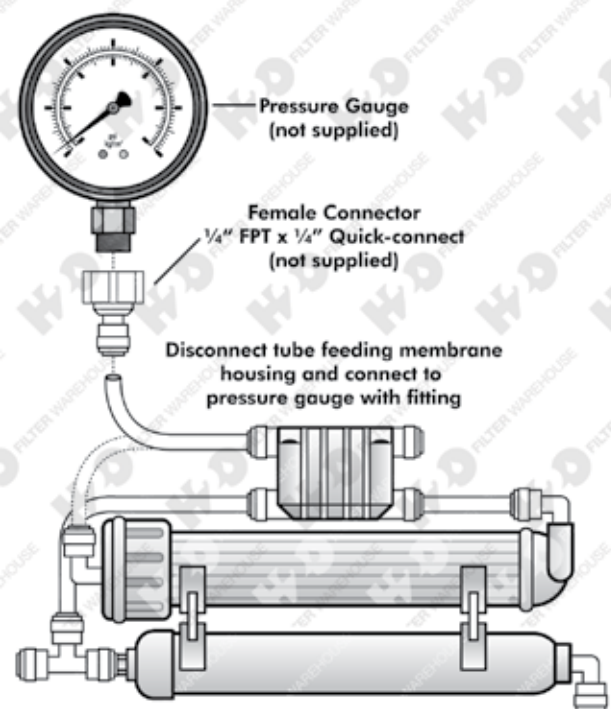

PRESSURE TEMPERATURE CHART

Temp °F	35 PSI	40 PSI	45 PSI	50 PSI	55 PSI	60 PSI	65 PSI	70 PSI	75 PSI	80 PSI	85 PSI	90 PSI	95 PSI	100 PSI	105 PSI	110 PSI
45	0.2321	0.2653	0.2985	0.3316	0.3648	0.3979	0.4311	0.4643	0.4974	0.5306	0.5638	0.5969	0.6301	0.6632	0.6964	0.7296
46	0.2417	0.2762	0.3108	0.3453	0.3798	0.4144	0.4489	0.4834	0.5179	0.5525	0.5870	0.6215	0.6561	0.6906	0.7251	0.7597
47	0.2513	0.2872	0.3231	0.3590	0.3949	0.4308	0.4667	0.5026	0.5385	0.5744	0.6103	0.6462	0.6821	0.7179	0.7538	0.7897
48	0.2609	0.2981	0.3354	0.3726	0.4099	0.4472	0.4844	0.5217	0.5590	0.5962	0.6335	0.6708	0.7080	0.7453	0.7826	0.8198
49	0.2704	0.3091	0.3477	0.3863	0.4250	0.4636	0.5022	0.5409	0.5795	0.6181	0.6568	0.6954	0.7340	0.7726	0.8113	0.8499
50	0.2800	0.3200	0.3600	0.4000	0.4400	0.4800	0.5200	0.5600	0.6000	0.6400	0.6800	0.7200	0.7600	0.8000	0.8400	0.8800
51	0.2896	0.3309	0.3723	0.4137	0.4550	0.4964	0.5378	0.5791	0.6205	0.6619	0.7032	0.7446	0.7860	0.8274	0.8687	0.9101
52	0.2991	0.3419	0.3846	0.4274	0.4701	0.5128	0.5556	0.5983	0.6410	0.6838	0.7265	0.7692	0.8120	0.8547	0.8974	0.9402
53	0.3087	0.3528	0.3969	0.4410	0.4851	0.5292	0.5733	0.6174	0.6615	0.7056	0.7497	0.7938	0.8379	0.8821	0.9262	0.9703
54	0.3183	0.3638	0.4092	0.4547	0.5002	0.5456	0.5911	0.6366	0.6821	0.7275	0.7730	0.8185	0.8639	0.9094	0.9549	1.0003
55	0.3279	0.3747	0.4215	0.4684	0.5152	0.5621	0.6089	0.6557	0.7026	0.7494	0.7962	0.8431	0.8899	0.9368	0.9836	1.0304
56	0.3374	0.3856	0.4338	0.4821	0.5303	0.5785	0.6267	0.6749	0.7231	0.7713	0.8195	0.8677	0.9159	0.9641	1.0123	1.0605
57	0.3470	0.3966	0.4462	0.4957	0.5453	0.5949	0.6444	0.6940	0.7436	0.7932	0.8427	0.8923	0.9419	0.9915	1.0410	1.0906
58	0.3566	0.4075	0.4585	0.5094	0.5603	0.6113	0.6622	0.7132	0.7641	0.8150	0.8660	0.9169	0.9679	1.0188	1.0697	1.1207
59	0.3662	0.4185	0.4708	0.5231	0.5754	0.6277	0.6800	0.7323	0.7846	0.8369	0.8892	0.9415	0.9938	1.0462	1.0985	1.1508
60	0.3757	0.4294	0.4831	0.5368	0.5904	0.6441	0.6978	0.7515	0.8051	0.8588	0.9125	0.9662	1.0198	1.0735	1.1272	1.1809
61	0.3853	0.4403	0.4954	0.5504	0.6055	0.6605	0.7156	0.7706	0.8256	0.8807	0.9357	0.9908	1.0458	1.1009	1.1559	1.2109
62	0.3949	0.4513	0.5077	0.5641	0.6205	0.6769	0.7333	0.7897	0.8462	0.9026	0.9590	1.0154	1.0718	1.1282	1.1846	1.2410
63	0.4044	0.4622	0.5200	0.5778	0.6356	0.6933	0.7511	0.8089	0.8667	0.9244	0.9822	1.0400	1.0978	1.1556	1.2133	1.2711
64	0.4140	0.4732	0.5323	0.5915	0.6506	0.7097	0.7689	0.8280	0.8872	0.9463	1.0055	1.0646	1.1238	1.1829	1.2421	1.3012
65	0.4236	0.4841	0.5446	0.6051	0.6656	0.7262	0.7867	0.8472	0.9077	0.9682	1.0287	1.0892	1.1497	1.2103	1.2708	1.3313
66	0.4332	0.4950	0.5569	0.6188	0.6807	0.7426	0.8044	0.8663	0.9282	0.9901	1.0520	1.1138	1.1757	1.2376	1.2995	1.3614
67	0.4427	0.5060	0.5692	0.6325	0.6957	0.7590	0.8222	0.8855	0.9487	1.0120	1.0752	1.1385	1.2017	1.2650	1.3282	1.3915
68	0.4523	0.5169	0.5815	0.6462	0.7108	0.7754	0.8400	0.9046	0.9692	1.0338	1.0985	1.1631	1.2277	1.2923	1.3569	1.4215
69	0.4619	0.5279	0.5938	0.6598	0.7258	0.7918	0.8578	0.9238	0.9897	1.0557	1.1217	1.1877	1.2537	1.3197	1.3856	1.4516
70	0.4715	0.5388	0.6062	0.6735	0.7409	0.8082	0.8756	0.9429	1.0103	1.0776	1.1450	1.2123	1.2797	1.3470	1.4144	1.4817
71	0.4810	0.5497	0.6185	0.6872	0.7559	0.8246	0.8933	0.9621	1.0308	1.0995	1.1682	1.2369	1.3056	1.3744	1.4431	1.5118
72	0.4906	0.5607	0.6308	0.7009	0.7709	0.8410	0.9111	0.9812	1.0513	1.1214	1.1915	1.2615	1.3316	1.4017	1.4718	1.5419
73	0.5002	0.5716	0.6431	0.7145	0.7860	0.8574	0.9289	1.0003	1.0718	1.1432	1.2147	1.2862	1.3576	1.4291	1.5005	1.5720
74	0.5097	0.5826	0.6554	0.7282	0.8010	0.8738	0.9467	1.0195	1.0923	1.1651	1.2379	1.3108	1.3836	1.4564	1.5292	1.6021
75	0.5193	0.5935	0.6677	0.7419	0.8161	0.8903	0.9644	1.0386	1.1128	1.1870	1.2612	1.3354	1.4096	1.4838	1.5579	1.6321
76	0.5289	0.6044	0.6800	0.7556	0.8311	0.9067	0.9822	1.0578	1.1333	1.2089	1.2844	1.3600	1.4356	1.5111	1.5867	1.6622
77	0.5385	0.6154	0.6923	0.7692	0.8462	0.9231	1.0000	1.0769	1.1538	1.2308	1.3077	1.3846	1.4615	1.5385	1.6154	1.6923
78	0.5480	0.6263	0.7046	0.7829	0.8612	0.9395	1.0178	1.0961	1.1744	1.2526	1.3309	1.4092	1.4875	1.5658	1.6441	1.7224
79	0.5576	0.6373	0.7169	0.7966	0.8762	0.9559	1.0356	1.1152	1.1949	1.2745	1.3542	1.4338	1.5135	1.5932	1.6728	1.7525
80	0.5672	0.6482	0.7292	0.8103	0.8913	0.9723	1.0533	1.1344	1.2154	1.2964	1.3774	1.4585	1.5395	1.6205	1.7015	1.7826
81	0.5768	0.6591	0.7415	0.8239	0.9063	0.9887	1.0711	1.1535	1.2359	1.3183	1.4007	1.4831	1.5655	1.6479	1.7303	1.8126
82	0.5863	0.6701	0.7538	0.8376	0.9214	1.0051	1.0889	1.1726	1.2564	1.3402	1.4239	1.5077	1.5915	1.6752	1.7590	1.8427
83	0.5959	0.6810	0.7662	0.8513	0.9364	1.0215	1.1067	1.1918	1.2769	1.3621	1.4472	1.5323	1.6174	1.7026	1.7877	1.8728
84	0.6055	0.6920	0.7785	0.8650	0.9515	1.0379	1.1244	1.2109	1.2974	1.3839	1.4704	1.5569	1.6434	1.7299	1.8164	1.9029
85	0.6150	0.7029	0.7908	0.8786	0.9665	1.0544	1.1422	1.2301	1.3179	1.4058	1.4937	1.5815	1.6694	1.7573	1.8451	1.9330
86	0.6246	0.7138	0.8031	0.8923	0.9815	1.0708	1.1600	1.2492	1.3385	1.4277	1.5169	1.6062	1.6954	1.7846	1.8738	1.9631
87	0.6342	0.7248	0.8154	0.9060	0.9966	1.0872	1.1778	1.2684	1.3590	1.4496	1.5402	1.6308	1.7214	1.8120	1.9026	1.9932
88	0.6438	0.7357	0.8277	0.9197	1.0116	1.1036	1.1956	1.2875	1.3795	1.4715	1.5634	1.6554	1.7474	1.8393	1.9313	2.0232
89	0.6533	0.7467	0.8400	0.9333	1.0267	1.1200	1.2133	1.3067	1.4000	1.4933	1.5867	1.6800	1.7733	1.8667	1.9600	2.0533
90	0.6629	0.7576	0.8523	0.9470	1.0417	1.1364	1.2311	1.3258	1.4205	1.5152	1.6099	1.7046	1.7993	1.8940	1.9887	2.0834
91	0.6725	0.7685	0.8646	0.9607	1.0568	1.1528	1.2489	1.3450	1.4410	1.5371	1.6332	1.7292	1.8253	1.9214	2.0174	2.1135
92	0.6821	0.7795	0.8769	0.9744	1.0718	1.1692	1.2667	1.3641	1.4615	1.5590	1.6564	1.7538	1.8513	1.9487	2.0462	2.1436
93	0.6916	0.7904	0.8892	0.9880	1.0868	1.1856	1.2844	1.3832	1.4821	1.5809	1.6797	1.7785	1.8773	1.9761	2.0749	2.1737
94	0.7012	0.8014	0.9015	1.0017	1.1019	1.2021	1.3022	1.4024	1.5026	1.6027	1.7029	1.8031	1.9032	2.0034	2.1036	2.2038
95	0.7108	0.8123	0.9138	1.0154	1.1169	1.2185	1.3200	1.4215	1.5231	1.6246	1.7262	1.8277	1.9292	2.0308	2.1323	2.2338

Reverse Osmosis Installation Diagram

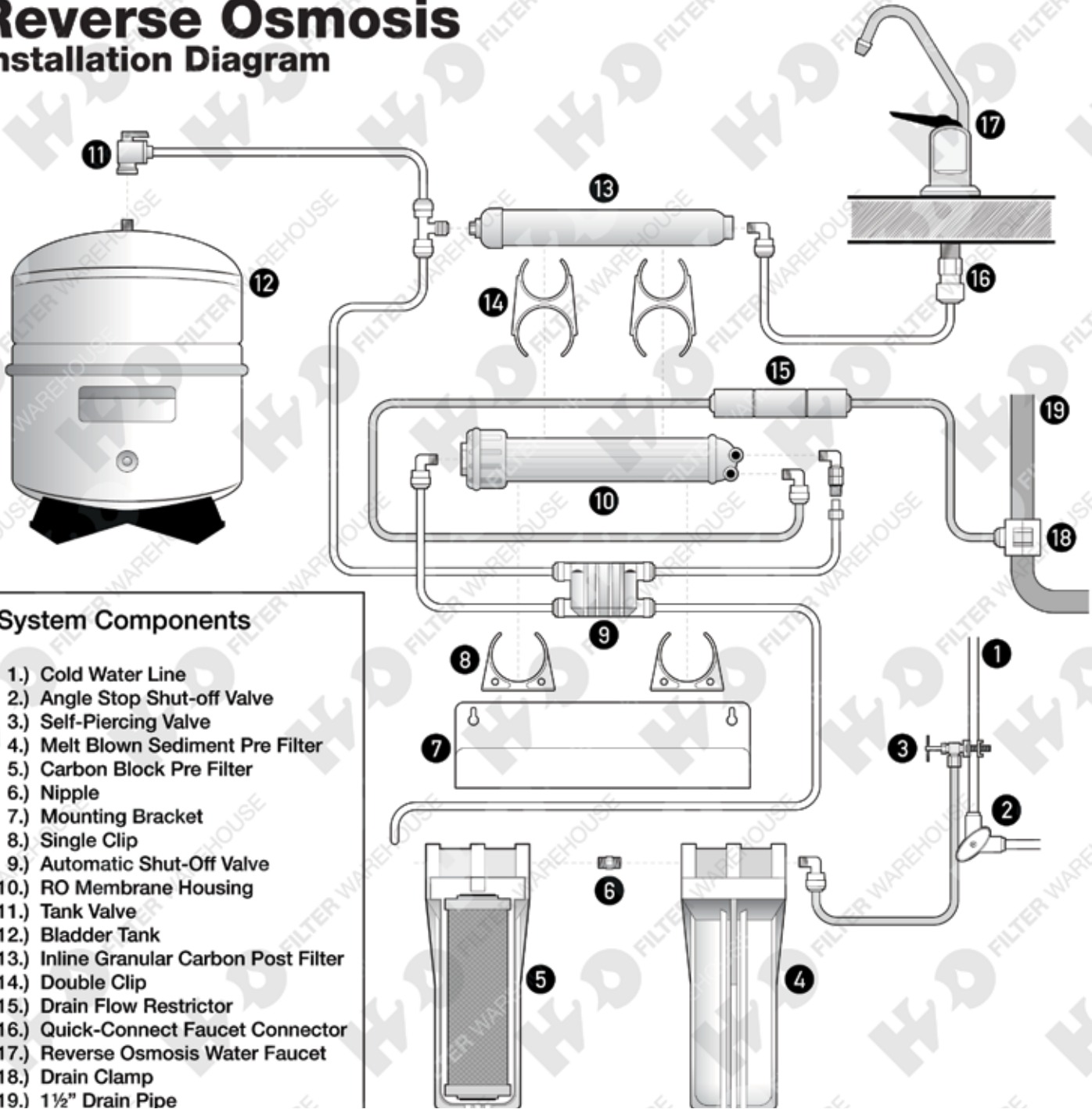

System Components

- 1.) Cold Water Line
- 2.) Angle Stop Shut-off Valve
- 3.) Self-Piercing Valve
- 4.) Melt Blown Sediment Pre Filter
- 5.) Carbon Block Pre Filter
- 6.) Nipple
- 7.) Mounting Bracket
- 8.) Single Clip
- 9.) Automatic Shut-Off Valve
- 10.) RO Membrane Housing
- 11.) Tank Valve
- 12.) Bladder Tank
- 13.) Inline Granular Carbon Post Filter
- 14.) Double Clip
- 15.) Drain Flow Restrictor
- 16.) Quick-Connect Faucet Connector
- 17.) Reverse Osmosis Water Faucet
- 18.) Drain Clamp
- 19.) 1/2" Drain Pipe